

Linear

LINI-S Glow A030 (30W) Fixture Guide

KKDC

Indoor | Surface | Output up to 2010lm/m (613lm/ft)



Key applications

- ✓ Architectural detail
- ✓ Cabinet & furniture
- ✓ Cove lighting
- ✓ Direct lighting
- ✓ Display case
- ✓ Hand rail
- ✓ Interior
- ✓ Mirror back lighting
- ✓ Shelving display

Key features

- ✓ Custom lengths
- ✓ Constant Voltage (CV)
- ✓ Diffusion: homogenous
- ✓ Direct view
- ✓ Extensive CCT range
- ✓ Illuminated ends
- ✓ IP40 dry area
- ✓ LEDmix RGBW

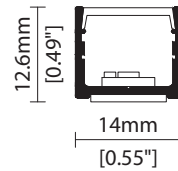

MOUNTING METHODS



KKCP-02 Standard clip

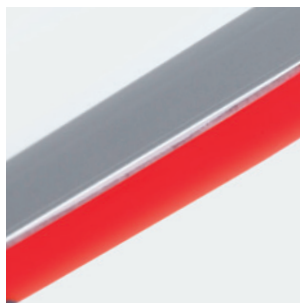

3M tape mounting

Linear

LINI-S Glow A030 (30W)

Specification sheet



Dimensions	H12/W14/L88-2011mm (H0.47/W0.55/L3.46-79.17in)
PCB Cut-point	38.46mm increment/1500mm max (1.51in increment/59.06in max)
LED Pitch	4.8mm - 208LED/m (0.19in - 64LED/ft)
Chip	A-line
Cover/Optics	Diffused (110°)
CCT	A-line: 2700K/3000K/4000K
LED binning	A-line: 3-step MacAdam ellipse
CRI	94
Lifetime	50,000 hours @ 25°C (50,000 hours @ 77°F)
Operating temp	T _a = -25 to 45°C (T _c max = 79.1°C) T _a = -13 to 113°F (T _c max = 174.4 °F)
IP Rating	IP40
Finish	Silver anodised
Mounting	Self-adhesive 3M tape / Clips
Power feed	Hardwire tails or male/female connectors
Control	0-10V/1-10V/DMX/DALI



LED Grading Key

Exclusive Grade *KKDC tuned CCT range
A-line* 3-step CCT range
 KKDC highest lumen efficacy LED

Power consumption	Supply voltage	Supply current
30W/m (9.14W/ft)	24V DC	1.25A/m (0.381A/ft)

Performance Data (3000K)

	R1	R2	R3	R4	R5	R6	R7	R8	R9	R10	R11	R12	R13	R14
A-line	95	95	94	94	93	93	96	89	73	88	95	78	95	96

Diffused Cover

		CRI	R9	Rf	Rg
A-line	2010lm/m (613lm/ft) 67 lm/W	94	73	-	-

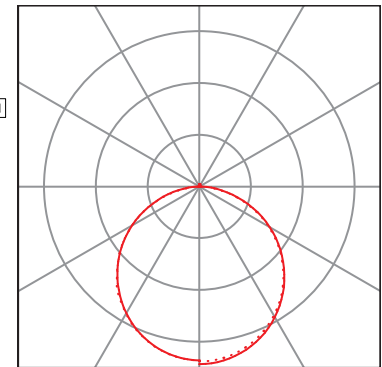
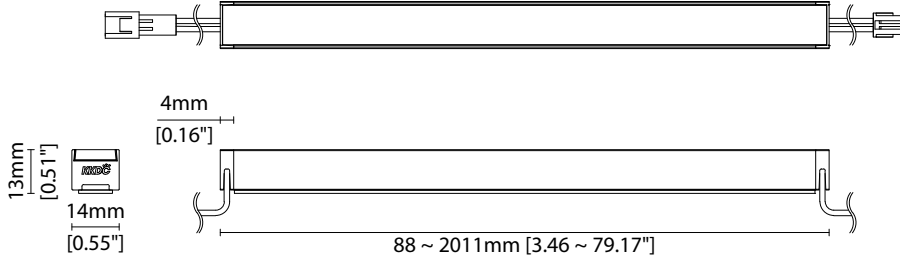

— C0 / C180 cd / 1000 lm - - - C90 / C270

Data derived from independent UKAS/IESNA LM-79-08 accredited testing of production samples.

LINE-S Glow A030 (30W)

Code Table



Fixture

Model	Finish	Cover ¹	Grade ²	LED	Colour (CCT)	Length Availability ³	IP	Cable Length	Power Feed ⁴	Input	
LINE-S Glow	Silver Anodised	Diffused	A- A	A030	030	2700K 27	IP40 40	50mm/1.97"	Single no sheath tail Double no sheath tail Single no sheath IP20 connector Double no sheath IP20 connector	S00X D00X S20X D20X	DC 24V g
					3000K 30	300mm/11.81"					
					4000K 40	1000mm/39.37"					
					m 94.4-2011mm 41.7mm increments						
		i 3.72-79.17in 1.64in increments		(Specify length code OR total run length)							

¹ Refer to **Cover/Lens Options** on **Options** pages

² Refer to **LED Grading Key** on **Specification sheet** page

³ Refer to **Length Availability List** or enter total run length instead of length code

⁴ Refer to **Power Feed Options** on **Options** pages

Code Example:

SG	-	SA	-	C	-	A	-	030	-	30	-	m	511	-	40	-	0300	-	D00X	-	g
LINE-S Glow		Silver Anodised		Diffused		A-		A030		3000K		511.4mm		IP40		300mm/11.81"		Double no sheath tail		DC 24V	

Accessories

Mounting Accessories

KKCP-02	Clip (1no.)
KKCP-52	Clip (500no.)

* Refer to **Mounting accessories** on **Accessories** pages

Connection Accessories

KKCN-01	2 PIN male & female 50mm (1.97in) pair
KKCN-03	2 PIN male & female 300mm (11.81in) pair
KKCN-06	2 PIN 300mm (11.81in) extension lead

* Refer to **Power feed** on **Accessories** pages

PSU/Driver

0-10V/1-10V/DALI/DMX

* Refer to **Driver/PSU Options** page for details or provide requirement and KKDC to offer the suitable option

LED Engine Variants (LED Strip Type)

Colour	LED	Lumen/m	Lumen/ft	W/m	W/ft	Spec Doc	Length	Increment
Single CCT	A030	2010	613	30	9.14	LINE-S Glow A030	88-2011 (3.46-79.17in)	38.46mm (3.46in)
Warm Dim/Dynamic White	R209	1030	314	25	7.62	LINE-S Glow R209	94.4-2011mm (3.70-79.17in)	41.7mm (1.64in)
RGBW	R201	604	184	20	6.1	LINE-S Glow RGBW	136-2011mm (5.35-79.17in)	62.5mm (2.46in)

* Performance data: A-line, diffused cover, 3000K

Linear

LINI-S Glow A030 (30W) Length Availability List



Length Code		Fixture Length ¹		LED Strip ²		End Cap Dimension ³		Wattage (W)	Output (lm)
Metric	Imperial(US)	Metric	Imperial(US)	Metric	Imperial(US)	Metric	Imperial(US)		3000K (Test Data)
m0088	i0003	88mm	3.46in	77mm	3.03in	8mm	0.31in	2.31	155
m0126	i0005	126mm	4.98in	115mm	4.54in	8mm	0.31in	3.46	232
m0165	i0006	165mm	6.49in	154mm	6.06in	8mm	0.31in	4.62	310
m0203	i0008	203mm	8.00in	192mm	7.57in	8mm	0.31in	5.77	387
m0242	i0010	242mm	9.52in	231mm	9.09in	8mm	0.31in	6.92	464
m0280	i0011	280mm	11.03in	269mm	10.60in	8mm	0.31in	8.08	541
m0319	i0013	319mm	12.55in	308mm	12.11in	8mm	0.31in	9.23	618
m0357	i0014	357mm	14.06in	346mm	13.63in	8mm	0.31in	10.38	695
m0396	i0016	396mm	15.57in	385mm	15.14in	8mm	0.31in	11.54	773
m0434	i0017	434mm	17.09in	423mm	16.66in	8mm	0.31in	12.69	850
m0473	i0019	473mm	18.60in	462mm	18.17in	8mm	0.31in	13.85	928
m0511	i0020	511mm	20.12in	500mm	19.68in	8mm	0.31in	15.00	1005
m0549	i0022	549mm	21.63in	538mm	21.20in	8mm	0.31in	16.15	1082
m0588	i0023	588mm	23.15in	577mm	22.71in	8mm	0.31in	17.31	1160
m0626	i0025	626mm	24.66in	615mm	24.23in	8mm	0.31in	18.46	1237
m0665	i0026	665mm	26.17in	654mm	25.74in	8mm	0.31in	19.62	1315
m0703	i0028	703mm	27.69in	692mm	27.26in	8mm	0.31in	20.77	1392
m0742	i0029	742mm	29.20in	731mm	28.77in	8mm	0.31in	21.92	1469
m0780	i0031	780mm	30.72in	769mm	30.28in	8mm	0.31in	23.08	1546
m0819	i0032	819mm	32.23in	808mm	31.80in	8mm	0.31in	24.23	1623
m0857	i0034	857mm	33.75in	846mm	33.31in	8mm	0.31in	25.38	1700
m0896	i0035	896mm	35.26in	885mm	34.83in	8mm	0.31in	26.54	1778
m0934	i0037	934mm	36.77in	923mm	36.34in	8mm	0.31in	27.69	1855
m0973	i0038	973mm	38.29in	962mm	37.85in	8mm	0.31in	28.85	1933
m1011	i0040	1011mm	39.80in	1000mm	39.37in	8mm	0.31in	30.00	2010
m1049	i0041	1049mm	41.32in	1038mm	40.88in	8mm	0.31in	31.15	2087
m1088	i0043	1088mm	42.83in	1077mm	42.40in	8mm	0.31in	32.31	2165
m1126	i0044	1126mm	44.34in	1115mm	43.91in	8mm	0.31in	33.46	2242
m1165	i0046	1165mm	45.86in	1154mm	45.43in	8mm	0.31in	34.62	2320
m1203	i0047	1203mm	47.37in	1192mm	46.94in	8mm	0.31in	35.77	2397
m1242	i0049	1242mm	48.89in	1231mm	48.45in	8mm	0.31in	36.92	2474
m1280	i0050	1280mm	50.40in	1269mm	49.97in	8mm	0.31in	38.08	2551
m1319	i0052	1319mm	51.92in	1308mm	51.48in	8mm	0.31in	39.23	2628
m1357	i0053	1357mm	53.43in	1346mm	53.00in	8mm	0.31in	40.38	2705
m1396	i0055	1396mm	54.94in	1385mm	54.51in	8mm	0.31in	41.54	2783
m1434	i0056	1434mm	56.46in	1423mm	56.02in	8mm	0.31in	42.69	2860
m1473	i0058	1472mm	57.97in	1461mm	57.54in	8mm	0.31in	43.85	2938
m1511	i0059	1511mm	59.49in	1500mm	59.05in	8mm	0.31in	45.00	3015
m1549	i0061	1549mm	61.00in	1538mm	60.57in	8mm	0.31in	46.15	3092
m1588	i0063	1588mm	62.51in	1577mm	62.08in	8mm	0.31in	47.31	3170
m1626	i0064	1626mm	64.03in	1615mm	63.60in	8mm	0.31in	48.46	3247
m1665	i0066	1665mm	65.54in	1654mm	65.11in	8mm	0.31in	49.62	3325
m1703	i0067	1703mm	67.06in	1692mm	66.62in	8mm	0.31in	50.77	3402

LINI-S Glow A030 (30W)

Length Availability List



Length Code		Fixture Length ¹		LED Strip ²		End Cap Dimension ³		Wattage (W)	Output (lm)
Metric	Imperial(US)	Metric	Imperial(US)	Metric	Imperial(US)	Metric	Imperial(US)		3000K (Test Data)
m1742	i0069	1742mm	68.57in	1731mm	68.14in	8mm	0.31in	51.92	3479
m1780	i0070	1780mm	70.09in	1769mm	69.65in	8mm	0.31in	53.08	3556
m1819	i0072	1819mm	71.60in	1808mm	71.17in	8mm	0.31in	54.23	3633
m1857	i0073	1857mm	73.11in	1846mm	72.68in	8mm	0.31in	55.38	3710
m1896	i0075	1896mm	74.63in	1885mm	74.19in	8mm	0.31in	56.54	3788
m1934	i0076	1934mm	76.14in	1923mm	75.71in	8mm	0.31in	57.69	3865
m1973	i0078	1972mm	77.66in	1961mm	77.22in	8mm	0.31in	58.85	3943
m2011	i0079	2011mm	79.17in	2000mm	78.74in	8mm	0.31in	60.00	4020

¹ Actual total overall length of light fixture (LED strip + end caps + void/wire hole)

² Actual length of PCB strip

³ Actual length of 2x end caps

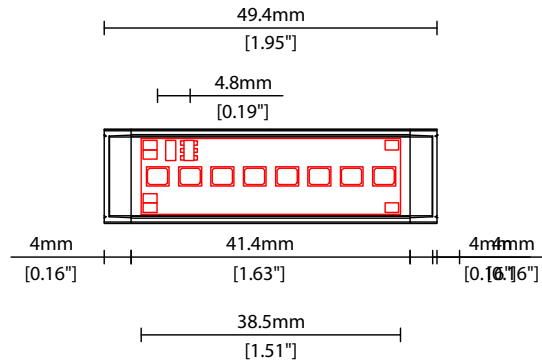

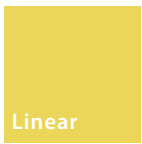

LINI-S Glow A030 (30W) Options



COVER/LENS OPTIONS

* Options are an integral part of the fixture ordering codes. Please refer to **Code Table** pages.

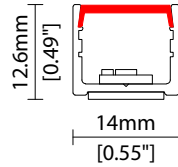

C Diffused cover

W14/H12.6mm (W0.55/H0.49")

POWER FEED OPTIONS

0050 S20X 50mm (1.97") Single no sheath IP20 connector

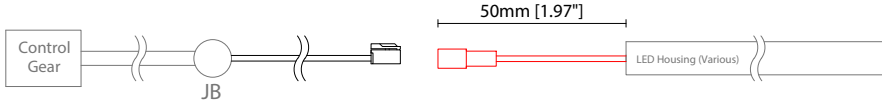

0050 D20X 50mm (1.97") Double no sheath IP20 connector

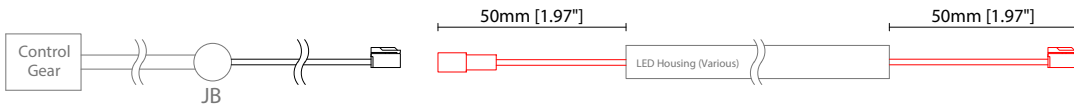

0300 S00X 300mm (11.81") Single no sheath tail

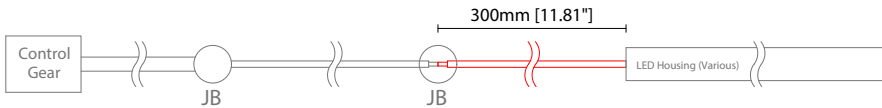

0300 D00X 300mm (11.81") Double no sheath tail

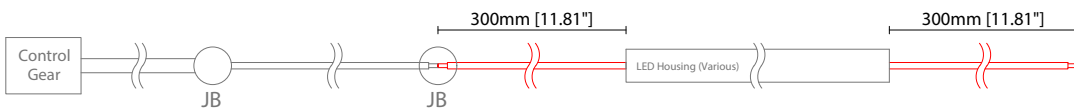

0300 S20X 300mm (11.81") Single no sheath IP20 connector

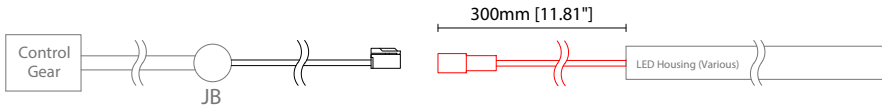

0300 D20X 300mm (11.81") Double no sheath IP20 connector

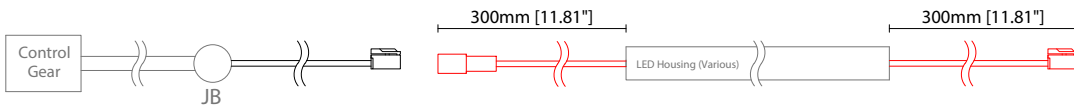

1000 S00X 1000mm (39.37") Single no sheath tail

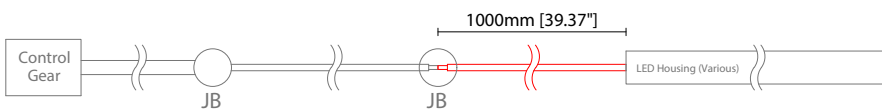

1000 D00X 1000mm (39.37") Double no sheath tail

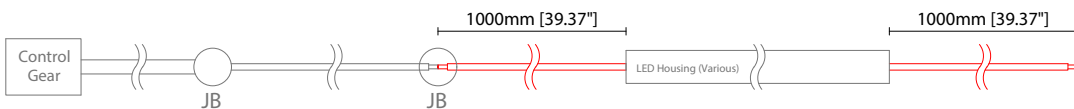

1000 S20X 1000mm (39.37") Single no sheath IP20 connector

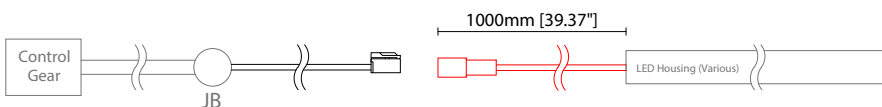

Key

Control Gear Power supply, sub-controllers & control systems

JB Junction box / cable connection

POWER FEED OPTIONS (CONTINUED)

1000 D20X 1000mm (39.37") Double no sheath IP20 connector

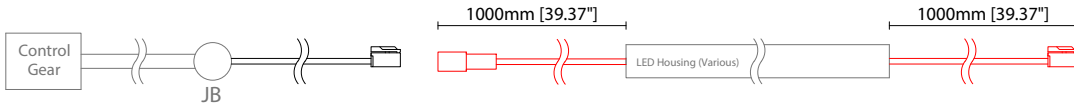

2 Pin Female Connector

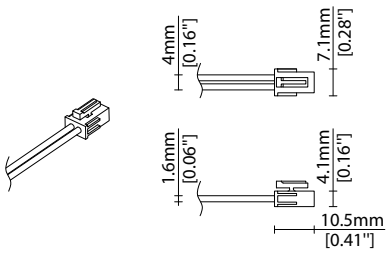

2 Pin Male Connector

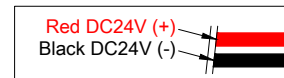
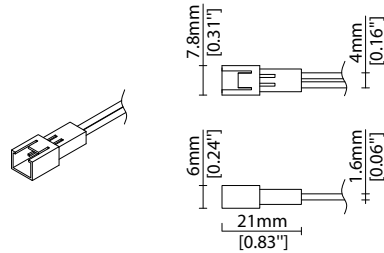

Key

Control Gear Power supply, sub-controllers & control systems
 JB Junction box / cable connection

MOUNTING ACCESSORIES

Note: Accessories are to be ordered separately with corresponding code shown below.

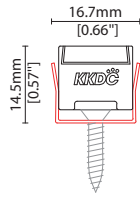

KKCP-02 (1no.)
KKCP-52 (500no.)

Clip (allow 3 per metre/40in)
S/Steel finish
L25/W16.7/H15.5mm
(L0.98/W0.66/H0.61")

POWER FEED

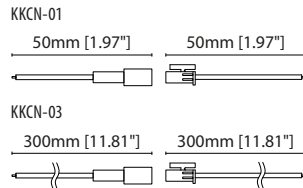
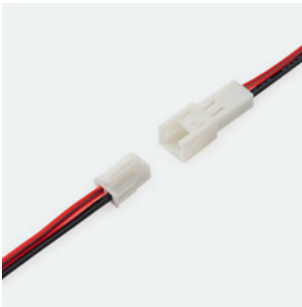

KKCN-01 50mm (1.97in) pair
KKCN-03 300mm (11.81in) pair
2 PIN male + female connector set



KKCN-06
2 PIN 300mm (11.81in) extension lead

KKDC CONTROL



IP20
Plastic housing
L170/W59/H29mm
(L6.69/W2.32/H1.14in)

KKDM-06 1-10V
visDIM dimmable sub-controller
(4 x 8A max @ 12-36V)



IP20
Plastic housing
L170/W53.4/H28mm
(L6.69/W2.10/H1.10in)

KKSC-05 DMX
visDIM dimmable sub-controller
(4 x 5A max @ 12-36V)

Linear

LINI-S Glow A030 (30W) Accessories

KKDC

KKDC CONTROL (CONTINUED)



IP20
Plastic housing
L170/W59/H29mm
(L6.69/W2.32/H1.14in)

KKDL-02 DALI

visDIM dimmable sub-controller
(4 x 8A max @ 12-36V)



IP20
Plastic housing
L166/W53.4/H23mm
(L6.54/W2.10/H0.91in)

KKDL-03 DALI

visDIM dimmable sub-controller
(4 x 5A max @ 12-36V)

AVAILABLE PSU OPTIONS

Control Mode	PSU (Order Code)	Input Voltage AC	Output Voltage DC	Rated Output Current	Rated Power	Dim %	IP Rating
Switched	CEN-60-24	90-295V	24V	2.5A	60W	-	IP67
	HLG-60H-24	90-305V	24V	2.5A	60W	-	IP67
	HLG-100H-24	90-305V	24V	4.0A	100W	-	IP67
	HLG-150H-24	90-305V	24V	6.3A	150W	-	IP67
	HLG-240H-24	90-305V	24V	10A	240W	-	IP67
0-10V (1-10V)	PWM-40-24	90-305V	24V	1.67A	40W	100-0.15 (100-10)	IP67
	PWM-60-24	90-305V	24V	2.5A	60W	100-0.15 (100-10)	IP67
	PWM-90-24	90-305V	24V	3.67A	90W	100-0.15 (100-10)	IP67
	PWM-120-24	90-305V	24V	5.0A	120W	100-0.15 (100-10)	IP67
DALI	LIN100A1	120-277V	24V	1A per channel	100W	100-0.1	IP66/IP40
DMX RGB	LIN100A1	120-277V	24V	1.33A per channel	100W	100-0.1	IP66/IP40
DMX RGBW	LIN100A1	120-277A	24V	1A per channel	100W	100-0.1	IP66/IP40

Flicker Free Options - Combination of PSU+ sub-controller

Control Mode	PSU (Order Code)	Sub-controller (Order Code)	Input Voltage AC	Output Voltage DC	Rated Output Current	Rated Power	Dim %	IP Rating PSU/ Sub-controller
0-10V or 1-10V	CEN-60-24	KKDM-06	90-295V	24V	2.5A	60W	100-0.9	IP67/IP20
	HLG-60H-24	KKDM-06	90-295V	24V	2.5A	60W	100-0.9	IP67/IP20
	HLG-100H-24	KKDM-06	90-295V	24V	4.0A	100W	100-0.9	IP67/IP20
	HLG-150H-24	KKDM-06	90-295V	24V	6.3A	150W	100-0.9	IP67/IP20
	HLG-240H-24	KKDM-06	90-295V	24V	10.0A	240W	100-0.9	IP67/IP20
DALI	CEN-60-24	KKDL-02/03	90-295V	24V	2.5A	60W	100-0.1	IP67/IP20
	HLG-60H-24	KKDL-02/03	90-305V	24V	2.5A	60W	100-0.1	IP67/IP20
	HLG-100H-24	KKDL-02/03	90-305V	24V	4.0A	100W	100-0.1	IP67/IP20
	HLG-150H-24	KKDL-02/03	90-305V	24V	6.3A	150W	100-0.1	IP67/IP20
	HLG-240H-24	KKDL-02/03	90-305V	24V	10.0A	240W	100-0.1	IP67/IP20
DMX RGB	CEN-60-24	KKSC-05	90-295V	24V	2.5A	60W	100-0.9	IP67/IP20
	HLG-60H-24	KKSC-05	90-305V	24V	2.5A	60W	100-0.9	IP67/IP20
	HLG-100H-24	KKSC-05	90-305V	24V	4A	100W	100-0.9	IP67/IP20
	HLG-150H-24	KKSC-05	90-305V	24V	6.3A	150W	100-0.9	IP67/IP20
	HLG-240H-24	KKSC-05	90-305V	24V	10.0A	240W	100-0.9	IP67/IP20

¹ The items shown above cover the most frequently used specification but does not exhaust the possible options

² PSU and/or driver can be chosen from the table, or KKDC may recommend the best option upon receipt of the controls requirement and installation environment

³ Electrical shop drawing will include detailed information of PSU and relevant control drivers

⁴ Cut sheets are available on the controls section of www.kkdc.lighting or upon request